

Save This Manual  
For Future Reference

**wolfcraft®**

**owners  
manual**

MODEL NO.  
2920

**CAUTION:**  
READ ALL  
INSTRUCTIONS  
CAREFULLY

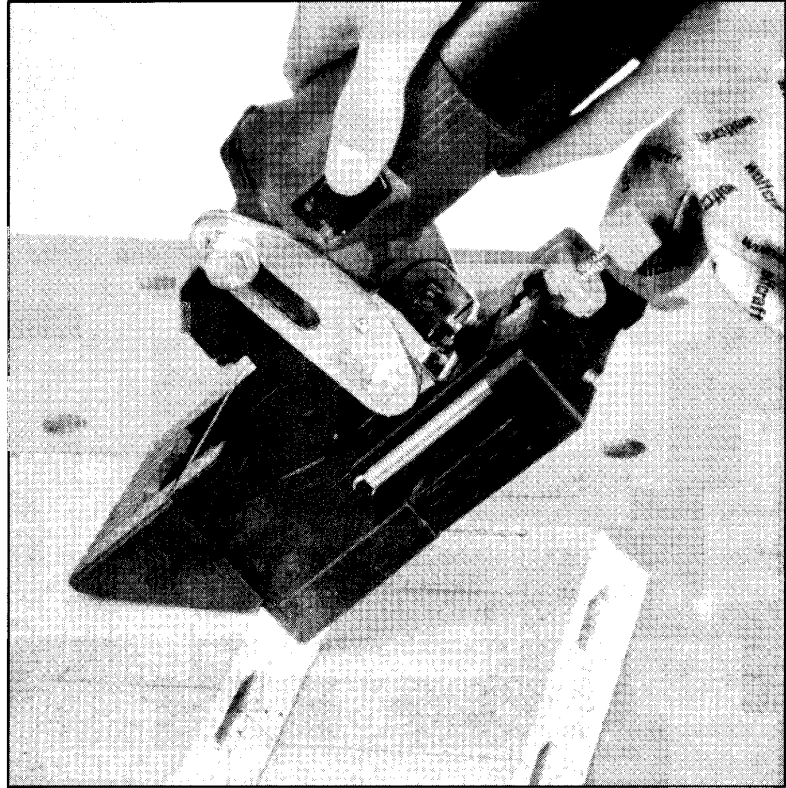

**wolfcraft®**

**BISCUIT JOINER**

- **assembly**
- **operating**

**WARNING: FAILURE TO HEED ALL SAFETY AND OPERATING INSTRUCTIONS AND WARNINGS REGARDING USE OF THIS PRODUCT CAN RESULT IN SERIOUS BODILY INJURY.**

## **GENERAL SAFETY INSTRUCTIONS FOR POWER TOOLS**

### **1. KNOW YOUR POWER TOOL**

Read the owner's manual carefully. Learn its application and limitations as well as the specific potential hazards peculiar to this tool.

### **2. GROUND ALL TOOLS (UNLESS DOUBLE INSULATED)**

If tool is equipped with an approved 3-conductor cord and a 3-prong grounding type plug to fit the proper grounding type receptacle. The green conductor in the cord is the grounding wire. Never connect the green wire to a live terminal.

### **3. KEEP GUARDS IN PLACE**

In working order, and in proper adjustment and alignment.

### **4. REMOVE ADJUSTING KEYS AND WRENCHES**

Form habit of checking to see that keys and adjusting wrenches are removed from tool before turning it on.

### **5. KEEP WORK AREA CLEAN**

Cluttered areas and benches invite accidents. Floor must not be slippery due to wax or sawdust.

### **6. AVOID DANGEROUS ENVIRONMENT**

Don't use power tools in damp or wet locations or expose them to rain. Keep work area well lighted. Provide adequate surrounding work space.

### **7. KEEP CHILDREN AWAY**

All visitors should be kept a safe distance from the work area.

### **8. MAKE WORKSHOP KID-PROOF**

—with padlocks, master switches, or by removing the starter keys.

### **9. DON'T FORCE TOOL**

It will do the job better and safer at the rate for which it was designed.

### **10. USE THE RIGHT TOOL**

Don't force tool or attachment to do a job it was not designed for.

### **11. WEAR RIGHT APPAREL**

Do not wear loose clothing, gloves, neckties or jewelry (rings, wristwatches) to get caught in moving parts. Nonslip footwear is recommended. Wear protective hair covering to contain long hair. Roll long sleeves above the elbow.

### **12. USE SAFETY GOGGLES (Head Protection)**

Wear Safety goggles (must comply with ANSI Z87.1) at all times. Also, use face or dust mask if cutting operation is dusty, and ear protectors (plugs or muffs) during extended periods of operation.

### **13. SECURE WORK**

Use clamps or a vise to hold work when practical. It's safer than using your hand, frees both hands to operate tool.

### **14. DON'T OVERREACH**

Keep proper footing and balance at all times.

### **15. MAINTAIN TOOLS WITH CARE**

Keep tools sharp and clean for best and safest performance. Follow instructions for lubricating and changing accessories.

### **16. DISCONNECT TOOLS**

before servicing; when changing accessories such as blades, bits, cutters, etc.

### **17. AVOID ACCIDENTAL STARTING**

Make sure switch is in "OFF" position before plugging in.

### **18. USE RECOMMENDED ACCESSORIES**

Consult the owner's manual for recommended accessories. Follow the instructions that accompany the accessories. The use of improper accessories may cause hazards.

### **19. NEVER STAND ON TOOL**

Serious injury could occur if the tool is tipped or if the cutting tool is accidentally contacted.

Do not store materials above or near the tool such that it is necessary to stand on the tool to reach them.

### **20. CHECK DAMAGED PARTS**

Before further use of the tool, a guard or other part that is damaged should be carefully checked to ensure that it will operate properly and perform its intended function. Check for alignment of moving parts, binding of moving parts, breakage of parts, mounting, and any other conditions that may affect its operation. A guard or other part that is damaged should be properly repaired or replaced.

### **21. DIRECTION OF FEED**

Feed work into a blade or cutter against the direction of rotation of the blade or cutter only.

### **22. NEVER LEAVE TOOL RUNNING UNATTENDED**

Turn power off. Don't leave tool until it comes to a complete stop.

# ADDITIONAL SAFETY INSTRUCTIONS FOR YOUR WOLFCRAFT BISCUIT JOINER

## 1. ALWAYS USE EYE PROTECTION

The operation of any power tool can result in foreign objects being thrown into the eyes, which can result in severe eye damage. Always wear safety goggles complying with ANSI Z87.1 before commencing power tool operation.

## 2. KEEP TOOL CLEAN

After every use, clean sawdust off the Biscuit Joiner and angle grinder.

3. **WARNING:** Always turn "OFF" the angle grinder and disconnect the power cord when installing the cutter and/or adjusting the depth of cut.

---

## INTRODUCTION

The Wolcraft Biscuit Joiner is designed for creating joints in pressed woods and other soft woods that do not accept dowels, dovetails or other types of joints. It can be used for a variety of purposes, including corners, mitres and "T" joints. With a special attachment (included), it can also be used to create grooves in plywood or other material.

The Wolcraft Biscuit Joiner attaches to most popular angle grinders. It can be used to cut #0, #10 and #20 slots at 45° 90° and 180° angles.

---

## UNPACKING AND CHECKING CONTENTS

Before beginning work, separate all the parts from the packaging materials and check each one against the parts list on page 8 to be sure all parts are there.

## ASSEMBLY— WOLFCRAFT BISCUIT JOINER

**WARNING:** You must read and understand all the instructions of your Biscuit Joiner as well as your angle grinder owner's manual before attempting to assemble and operate this product.

---

## ASSEMBLY INSTRUCTIONS

### ATTACHING DEPTH ADJUSTMENT DIAL

1. Slide long spring over threaded end of long screw.
2. Slide depth adjusting dial over threaded end of long screw as shown. The numbers on the dial should be facing orange knob.
3. Place square nut into small hole on moving section of joiner.
4. Insert entire long screw assembly into hole in back of joiner and turn clockwise until it is held by the nut. **DO NOT TIGHTEN ALL THE WAY TO THE DIAL.**

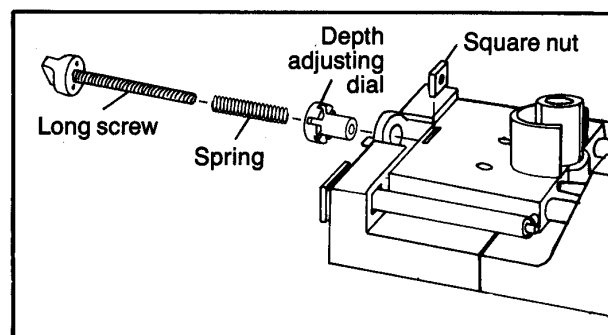

## ATTACHING ANGLE GRINDER TO JOINER

1. Place L-shaped guides over holes on top side of joiner as shown, with the slotted side resting on the joiner.
2. Insert medium-size (M6) washer on medium (M6) bolt and tighten until the bolt just hits the guide. The guide should still be able to slide back and forth to allow for the width of your angle grinder. Repeat for other side.
3. Place angle grinder guide on the outside of L-shaped guide, angled side toward the back. Align holes on both guides and insert medium (M6) bolt and washer through holes. Place nut on thread ends and tighten completely. Repeat for other side.
4. Insert angle grinder into chuck and tighten with wrench. (NOTE: Supplied size is 5/8" x 11. If your angle grinder does not fit, two reducing bushings have been supplied to adapt the joiner to your grinder—an M10 x 1.5 and M10 x 1.25.)
5. Slide angle grinder guides into sides of angle grinder, aligning the slots with the mounting holes in sides of angle grinder. Select proper size bolt and washer, insert and tighten all L-bracket bolts.
6. Place small, elastic end of dust bag over hole on right back side of joiner until snug. You are now ready to use your Wolfcraft Biscuit Joiner.

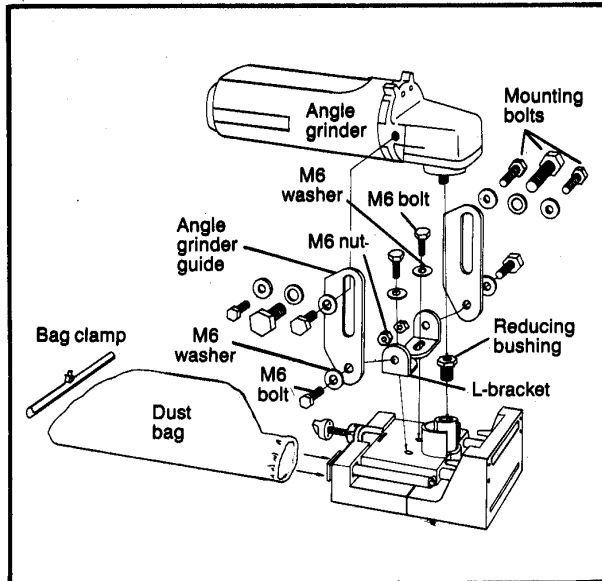

## HOW TO SET DEPTH FOR BISCUITS

1. Determine the size biscuit you wish to use—#0, #10 or #20.
2. Make sure the depth adjusting dial is properly adjusted: There are two arrows on the back of the joiner. Set the dial so those arrows point to 0. Then, WITH THE POWER DISCONNECTED, hold the base of the joiner with one hand and push the blade assembly forward with the other.
3. Check that the pointer on the right hand side of the joiner points to 0. If not, turn the orange knob on the long screw until it does.
4. You can now set your joiner for the size biscuit you wish to use by simply turning the dial to the proper reading.
5. When cutting, push joiner forward until it completely butts against surface of wood being cut. You now have a perfectly cut slot.

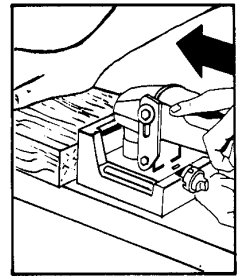
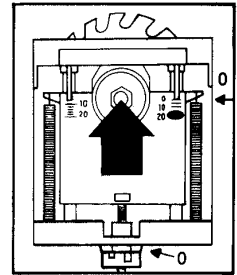

## MARKING SLOT LOCATIONS FOR STANDARD CUTS

1. Always begin with the joiner cutting into the end of the wood, rather than the face.
2. Mark center of slot at a point at least 2 1/2" from the outer edge of the board. Allow at least 1" between slots in multiple biscuit applications for best results. Mark all slots on both boards at the same time to assure proper alignment.
3. Align center point (thin line) of joiner with your pencil mark.
4. Turn on power and push joiner smoothly in line with your mark. When joiner has butted completely against surface being cut, pull back and then release power.

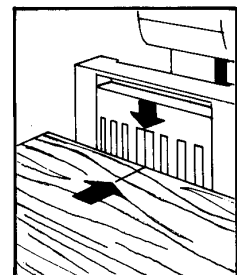
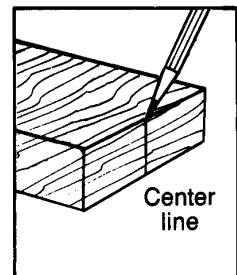

## HOW TO MAKE CORNER JOINTS

1. Fit the two pieces of wood together as they will appear in the final joint. Then lay the vertical piece on top of the horizontal piece and clamp both boards to work bench.
2. Mark center of slots on top board as detailed on Page Three.
3. Place a board equal to the thickness of the boards being cut under the joiner for support. Align the center mark on the face of the joiner with your pencil mark and make your cut in the top board. Repeat for all slots.
4. Turn joiner so cutting wheel is facing down and bottom of joiner is butted against top board. Align thin center line on bottom of joiner with your pencil marks and cut slot. Repeat for all slots.
5. Insert biscuits dry to check alignment and fit. If satisfactory, apply good quality carpenter's glue to both sides, insert biscuit(s) into one side and press together.

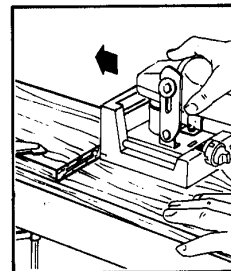
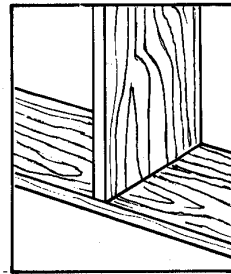
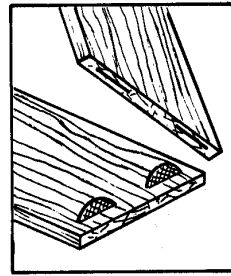
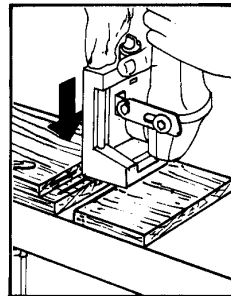
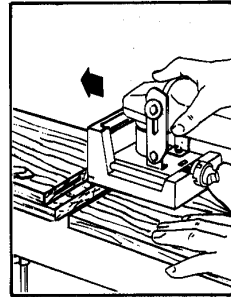
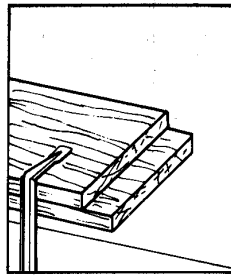

4. Turn joiner so cutting wheel is facing down and bottom of joiner is butted against top board. Align thin center line on bottom of joiner with your pencil marks and cut slot. Repeat for all slots.
5. Insert biscuits dry to check alignment and fit. If satisfactory, apply good quality carpenter's glue to both slots, insert biscuit(s) into one side and press together.

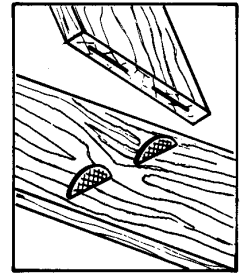
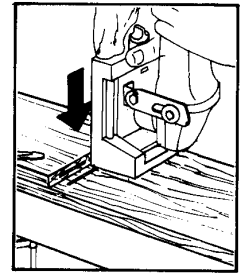

## HOW TO MAKE MITRE JOINTS

1. Attach adjustable fence flat side up using the M4 allen head screws, washers and nuts supplied in the hardware bag. Use top holes on joiner. Do not tighten completely.
2. Lay joiner flat on work bench and slide board underneath attachment to set height. Then tighten allen screws completely.
3. Align both boards with angles facing away from you. Top board should be back far enough to clear the joiner. Clamp boards to work bench.
4. Mark center of slots on top board as detailed on Page Three. Then set biscuit depth as detailed on Page Three.
5. Align the center mark on the face of the joiner with your pencil mark and make your cut in the top board. Repeat for all slots on both boards.
6. Insert biscuits dry to check alignment and fit. If satisfactory, apply good quality carpenter's glue to both sides, insert biscuit(s) into one side and press together.

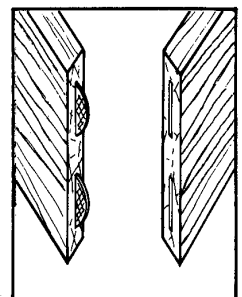
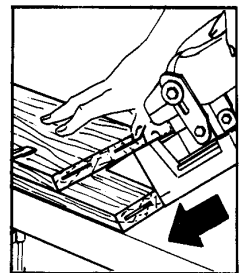
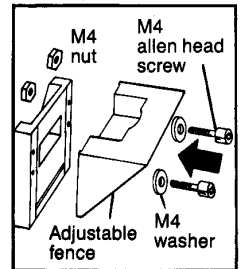

## HOW TO MAKE T-BUTT JOINTS

1. Fit the two pieces of wood together as they will appear in the final joint. Then lay the vertical piece on top of the horizontal piece and clamp both boards to work bench.
2. Mark center of slots on top board as detailed on Page Three. Then set biscuit depth as detailed on Page Three.
3. Align the center mark on the face of the joiner with your pencil mark and make your cut in the top board. Repeat for all slots.

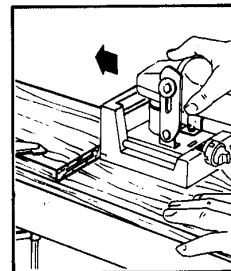
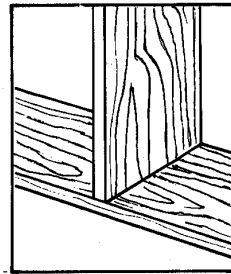

## HOW TO MAKE EDGE-TO-EDGE JOINTS

1. Align all boards as you want them to appear when finished. Mark center of slots on all boards as detailed on Page Three. Then set biscuit depth as detailed on Page Three.
2. Clamp boards to work bench one at a time. Align center mark on the face of the joiner with your pencil mark and cut slot. Repeat for all slots on BOTH SIDES of board.
3. Insert biscuits dry to check alignment and fit. If satisfactory, apply good quality carpenter's glue to both slots, insert biscuit(s) into one side and press together.

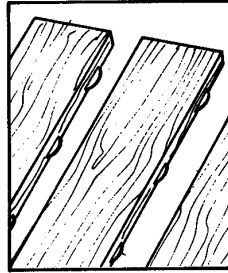
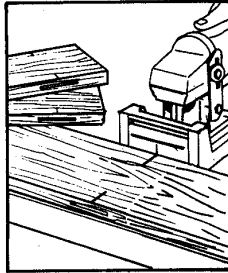

3. Clamp or hold the vertical (butting) board still, place joiner on work bench and align center mark on joiner with center mark on board.
4. Cut slot until joiner butts against board.  
Turn board 90° and repeat until all four slots are cut.
5. Turn joiner so cutting edge is facing down, align center mark on joiner with mark on board, and make cut. Repeat for all four sides.
6. Insert biscuits dry to check alignment and fit. If satisfactory, apply good quality carpenter's glue to both slots, insert biscuit(s) into one side and press together.

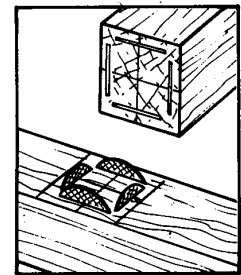
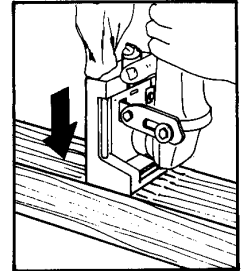
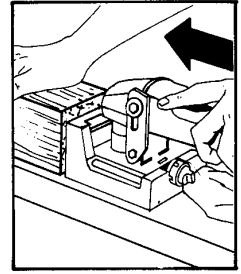

## HOW TO MAKE LEG AND RAIL JOINTS

NOTE: A square slot pattern is preferred for best results. However, a side-by-side pattern can also be used in low stress situations.

### SQUARE PATTERN:

1. Fit boards together as you would like them to appear when finished. Make a small mark where the horizontal and vertical boards meet.
2. Mark the center of the slots using a cross pattern. Be sure the marks on both boards match. (HINT: Snap a chalk line on one set of marks, press the other board on top of it to get an impression, then remark with pencil.) Set biscuit depth as detailed on Page Three.

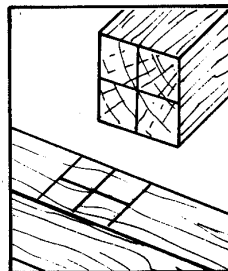

### PARALLEL PATTERN:

1. Attach adjustable fence to joiner with angle side up using supplied M4 allen screws, washers and nuts. Do not tighten completely.
2. Fit boards together as you would like them to appear when finished. Make a small mark where the horizontal and vertical boards meet.
3. Mark center of slot and slot locations on both boards. Be sure the marks on both boards match. (HINT: Snap a chalk line on one set of marks, press the other board on top of it to get an impression, then remark with pencil.) Set biscuit depth as detailed on Page Three.

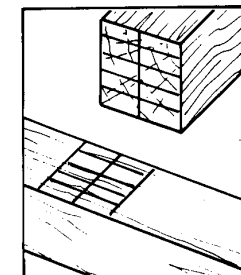
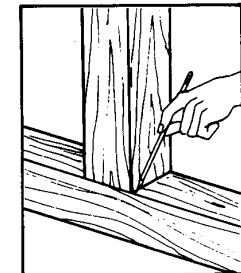
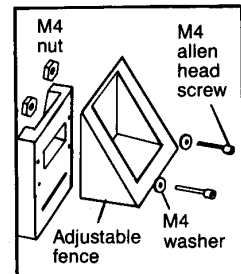

- Align center mark on butt edge of vertical board with center mark on joiner. Set angle guide so cutting edge is in line with the first slot mark and the guide rests on the top edge of the board. Tighten allen screws and make first cut.

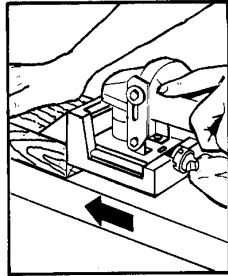

- Reset guide height until it matches the next slot mark and follow Step Four. Repeat for all marks.

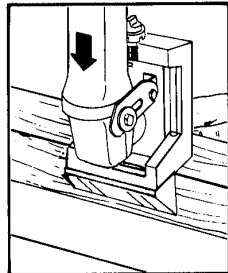

- Turn joiner so cutting edge is facing down, align center mark on joiner with mark on board, and make cut. Repeat for all four slots.

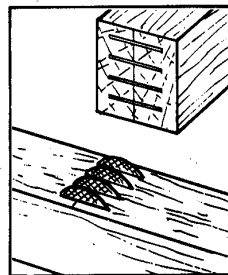

- Insert biscuits dry to check alignment and fit. If satisfactory, apply good quality carpenter's glue to both slots, insert biscuit(s) into one side and press together.

## HOW TO CUT SLOTS

For slots less than  $2\frac{3}{16}$ " from edge:

- Attach adjustable fence with angle side up as detailed in #1 under How to Make Edge-To-Edge Joints, Parallel pattern.
- Mark pencil line where you would like slot to be. With blade retracted, align center line on side of joiner with pencil line. Butt guide against side of board and tighten allen screws.
- Set slot depth (in millimeters) by pushing blade assembly forward and turning long screw. Use scale on left side of joiner to measure.
- Cut slot by sliding joiner evenly along entire length of board.

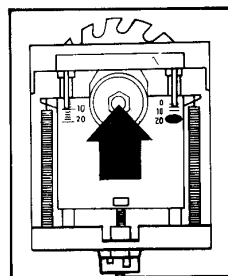
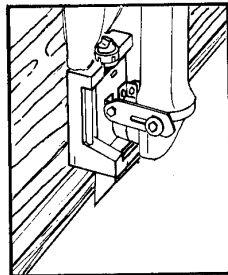

For slots more than  $2\frac{3}{16}$ " from edge:

- Mark pencil line where you would like slot to be. Set joiner on line, aligning center line on side of joiner with pencil line.
- Gently slide a second board up to the bottom of the joiner to use as a guide. Make sure board is parallel to your pencil line. Clamp both ends to the board to be cut and work bench.
- Set slot depth (in millimeters) by pushing blade assembly forward and turning long screw. Use scale on left side of joiner to measure.
- Cut slot by sliding joiner evenly along entire length of board.

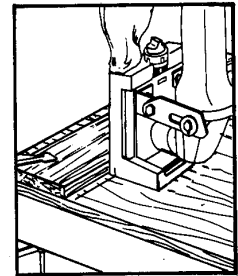
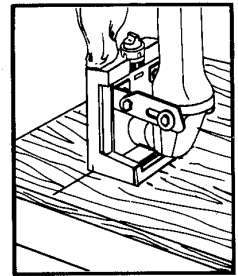

## CHANGING BLADES

- IMPORTANT! MAKE SURE POWER IS DISCONNECTED BEFORE STARTING.** Remove angle grinder from joiner.
- Remove allen screws on face of joiner using wrench provided.
- Turn joiner upside down so large bolt is showing. Be sure to note which way blades face.
- Hold chuck with wrench or pliers. Remove bolt with wrench.
- Carefully remove old blade and put new blade in its place. Reassemble by reinserting and tightening bolt, then reinstalling face plate.
- Double check to be sure blade is set to run in direction of arrow on face plate.

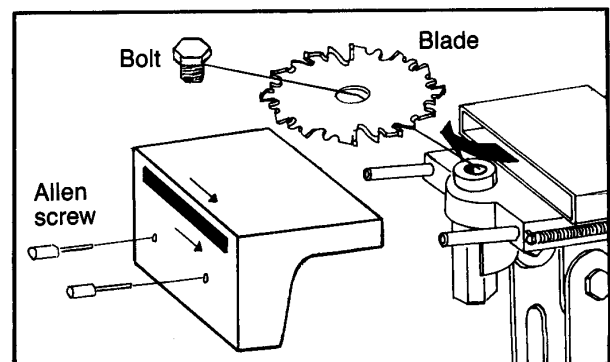

# wolcraft®

## owners manual

### MODEL NO. 2920

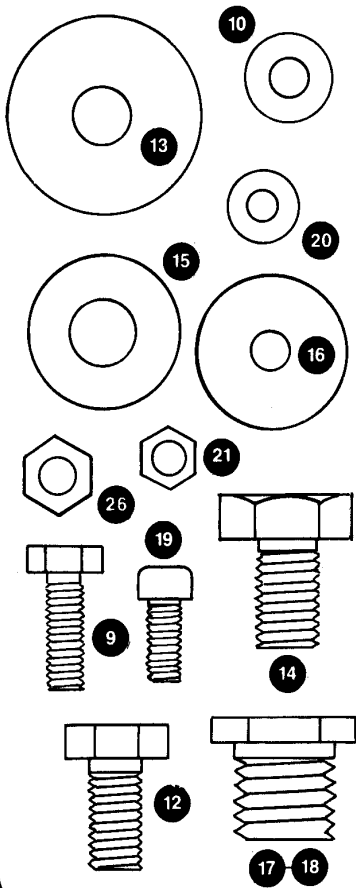

**ALWAYS MENTION STOCK NUMBER WHEN COMMUNICATING  
WITH US REGARDING YOUR WOLFCRAFT MODEL NO. 2920**

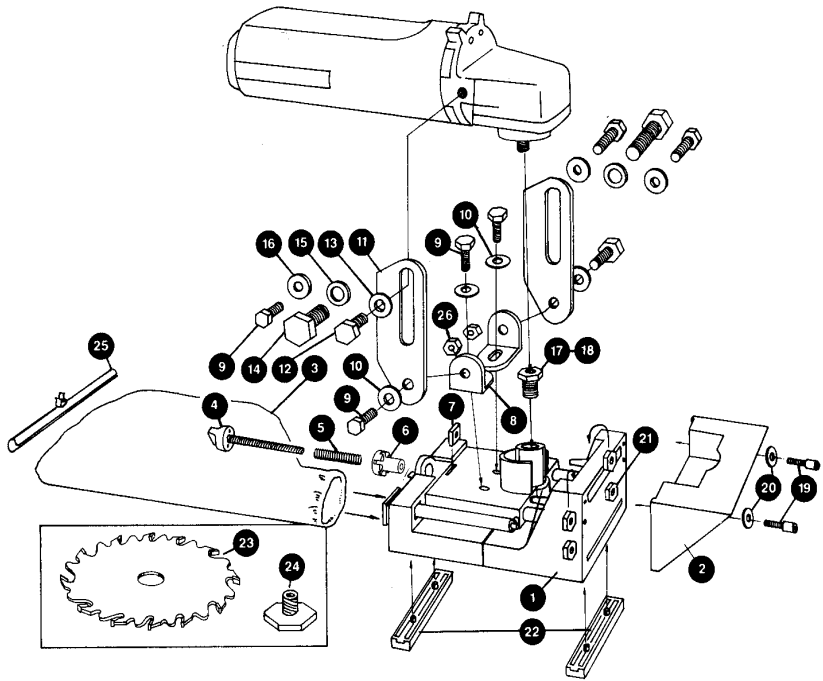

#### PARTS LIST FOR WOLFCRAFT BISCUIT JOINER MODEL NO. 2920

Key No.	Part No.	Description	Quan.
1	2920498	Joiner	1
2	116620062	Adjustable Fence	1
3	119800332	Dust Bag	1
4	116620058	Long Screw	1
5	117620011	Spring	1
6	116620002	Depth Adjusting Dial	1
7	116750135	Square Nut	1
8	117020018	L-shaped Guide	2
9	116720031	M6 Bolt	6
10	116700026	M6 Washer	2
11	117020019	Mounting Brackets	2
12	116720037	M8 Mounting Bolt	2
13	116720042	M8 Washer	2
14	116720038	M10 Mounting Bolt	2
15	116710050	M10 Washer	2
16	116730108	M4 Washer	4
17	117220004	M10 × 1.5 Chuck Adaptor	1
18	117220002	M10 × 1.25 Chuck Adaptor	1
19	116700014	M4 Allen Screw	2
20	116210051	M4 Washer	2
21	116700022	M4 Nut	4
22	116620063	Spacer	2
23	2924040	Cutting Blade	1
24	117220053	Blade Bolt	1
25	116620043	Bag Clamp	1
26	116700023	M6 Nut	2

Sold by Wolcraft, Inc., Itasca, IL. 60143 U.S.A.